



Pressure switch



Relative pressure switch

Type 521

The compact type 521 pressure switch is based upon the Huba Control developed thick film technology where the pressure measuring cell is fully welded.

Switching points set in factory are available both N/C and N/O function. Various electrical and pressure connections are available to suit given applications.

Pressure range

0 ... 2.5 – 600 bar

- + Compact, rugged construction
- + Welded without sealing parts
- + Saving time by quick cable mounting by the customer with swift connector
- + Large selection of connections available

Technical overview

Pressure range

Relative 0 ... 2.5 – 600 bar

Operating conditions

Medium	Liquids, gases and refrigerants (incl. ammonia)	
Temperature	Medium	-40 ... +135 °C
	Ambient	-30 ... +85 °C
	Storage	-50 ... +100 °C
Tolerable overload	≤ 6 bar	5 x FS
	> 6 bar	3 x FS (max. 1500 bar)
Rupture pressure	≤ 6 bar	10 x FS
	> 6 bar	6 x FS (max. 2500 bar)

Materials

Pressure Connection	Stainless steel 1.4404 / AISI 316L (inside thread Schrader 1.4305 / AISI 303 only)	
Plug accommodation	Polyarylamide 50% GF UL 94 V-0	
Materials in contact with medium	Pressure connection	Stainless steel 1.4404 / AISI 316L (inside thread Schrader 1.4305 / AISI 303 only)
	Sensor	Stainless steel

Electrical overview

Output	Semiconductor (open collector)	
Switching contact	High-Side Switch (PNP)	N/C contact or N/O contact
Switch load	High-Side Switch (PNP) max. 200 mA	
Power supply	7 ... 33 VDC	
Current consumption	< 4 mA	
Insulation voltage	500 VDC	

Dynamic response

Response time	< 2 ms, 1 ms typ.
Load cycle	< 100 Hz

Adjustment of switching points (factory set)

Upper switching point	8 ... 100% fs
Lower switching point	5 ... 97% fs
Hysteresis	≥ 3 % fs

Electrical connection

	Protection standard	Protection class
Swift connector with or without cable 1.5 m	IP 67	III
Connector M12x1	IP 67	III

Pressure connection

Inside thread	$\frac{7}{16}$ - 20 UNF	without or with Schrader
	G $\frac{1}{4}$	with O-Ring seal FPM (-30 ... +135 °C)
	$\frac{1}{2}$ - 14 NPT	≤ 60 bar
Outside thread	M20x1,5	sealed at front and manometer (combi)
	$\frac{7}{16}$ - 20 UNF	sealing cone 45°
	$\frac{1}{4}$ - 18 NPT	
	G $\frac{1}{4}$	sealed at back DIN EN ISO 1179-2 with Profile seal ring in FPM (-30 ... +135 °C)
	R $\frac{1}{4}$	EN 10226
	G $\frac{1}{2}$	sealed at back and manometer (combi) with Profile seal ring in FPM (-30 ... +135 °C)
	G $\frac{1}{2}$	sealed at front

Installation arrangement

Unrestricted

Tests / Admissions

Electromagnetic compatibility	CE conformity acc. EN 61326-2-3 and 50121-3-2
Shock acc. IEC 68-2-27	100 g, 11 ms half sine wave, all 6 directions, free fall from 1 m on concrete (6x)
Constant shock acc. IEC 68-2-29	40 g for 6 ms, 1000x all 3 directions
Vibration acc. IEC 68-2-6	20 g, 15 ... 2000 Hz, 15 ... 25 Hz with amplitude ± 15 mm, 1 Octave/min. all 3 directions, 50 constant load
UL	ANSI/UL 61010-1 acc. E325110
EAC	

Weight

~ 90 g

Packaging (Please state on order)

Single packaging in cardboard	accessories integrated
Multiple packaging in cardboard (25 pcs)	

Accuracy

Test conditions: 25°C, 45% RH, power supply 24 VDC

Parameter		Unit	
Switching points ¹⁾		% fs	± 0.5
Resolution		% fs	0.1
Thermal characteristic ²⁾	max.	% fs/10K	± 0.2
Long term stability acc. IEC EN 60770-1	max.	% fs	± 0.25

¹⁾ typ. ; max. 1.0% fs (incl. hysteresis and repeatability)

²⁾ -15 ... 85 °C

		1	2	3	4	5	6	7	8	9	10	11	
Order code selection table in bar		521.	X	X	X	X	X	X	X	X	X	X	
Pressure range ¹⁾	0 ... 2.5 bar	9	1	4									
	0 ... 4 bar	9	1	5									
	0 ... 6 bar	9	1	7									
	0 ... 10 bar	9	3	0									
	0 ... 16 bar	9	3	1									
	0 ... 25 bar	9	3	2									
	0 ... 40 bar	9	3	3									
	0 ... 60 bar	9	4	0									
	0 ... 100 bar	9	4	1									
	0 ... 160 bar	9	4	2									
	0 ... 250 bar	9	4	3									
	0 ... 400 bar	9	5	4									
	0 ... 600 bar	9	5	5									
Version	standard				S	0							
	for oxygen applications				S	1							
Switching contact	Contact N/O High-Side-Switch PNP						1						
	Contact N/C High-Side-Switch PNP						2						
Electrical connection	Swift connector without cable							0					
	Connector M12x1 ²⁾							3					
	Swift connector with cable 1.5 m							L					
						0			0	0	N		
Pressure connection ³⁾	Inside thread	7/16"-20 UNF sealing cone with Schrader							K		1		
		7/16"-20 UNF											
		G 1/4 with O-Ring seal FPM								1		1	
		1/2 -14 NPT (≤ 60 bar)								D		1	
	Outside thread	M20x1.5 sealed at front and manometer (combi)								E		1	
		7/16"-20 UNF sealing cone								2		1	
		1/4 -18 NPT								3		1	
		G 1/4 sealed at back DIN EN ISO 1179-2 with Profile seal ring in FPM								4		1	
		R 1/4 acc. to EN 10226								7		1	
		G 1/2 sealed at back and manometer with Profile seal ring in FPM								8		1	
G 1/2 sealed at front								9		1			
Pressure tip orifice ²⁾	without (Inclusive pressure tip orifice from 100 bar on)									0			
	with									2			
Material	Stainless steel 1.4305 / AISI 303										N		
pressure connection	Stainless steel 1.4404 / AISI 316L										1		
Switching points	Indicate W and state switching points on order (e.g.: W100/60bar)											W	

		1	2	3	4	5	6	7	8	9	10	11	
Order code selection table in psi		521.	X	X	X	X	X	X	X	X	X	X	
Pressure range ¹⁾	0 ... 30 psi	9	B	4									
	0 ... 60 psi	9	B	5									
	0 ... 100 psi	9	B	7									
	0 ... 200 psi	9	C	1									
	0 ... 300 psi	9	C	2									
	0 ... 500 psi	9	C	3									
	0 ... 750 psi	9	D	0									
	0 ... 1000 psi	9	D	1									
	0 ... 2000 psi	9	D	2									
	0 ... 3000 psi	9	D	3									
	0 ... 5000 psi	9	E	4									
	0 ... 7500 psi	9	E	5									
	Version	standard				S	0						
for oxygen applications					S	1							
Switching contact	Contact N/O High-Side-Switch PNP						1						
	Contact N/C High-Side-Switch PNP						2						
Electrical connection	Swift connector without cable							0					
	Connector M12x1 ²⁾							3					
	Swift connector with cable 1.5 m							L					
						0			0	0	N		
Pressure connection ³⁾	Inside thread	7/16"-20 UNF sealing cone with Schrader							K		1		
		7/16"-20 UNF											
		G 1/4 with O-Ring seal FPM								1		1	
		1/2 -14 NPT (≤ 870 psi)								D		1	
	Outside thread	M20x1.5 sealed at front and manometer (combi)								E		1	
		7/16"-20 UNF sealing cone								2		1	
		1/4 -18 NPT								3		1	
		G 1/4 sealed at back DIN EN ISO 1179-2 with Profile seal ring in FPM								4		1	
		R 1/4 acc. to EN 10226								7		1	
		G 1/2 sealed at back and manometer with Profile seal ring in FPM								8		1	
G 1/2 sealed at front								9		1			
Pressure tip orifice ²⁾	without (Inclusive pressure tip orifice from 2000 psi on)									0			
	with									2			
Material	Stainless steel 1.4305 / AISI 303										N		
pressure connection	Stainless steel 1.4404 / AISI 316L										1		
Switching points	Indicate W and state switching points on order (e.g.: W1000/400psi)											W	

¹⁾ Other pressure ranges on request

²⁾ Delivery without female connector

³⁾ Other pressure connections on request

Order code selection table in MPa		1	2	3	4	5	6	7	8	9	10	11		
		521.	X	X	X	X	X	X	X	X	X	X		
Pressure range ¹⁾	0 ... 0.25 MPa	9	G	4										
	0 ... 0.4 MPa	9	G	5										
	0 ... 0.6 MPa	9	G	7										
	0 ... 1 MPa	9	H	0										
	0 ... 1.6 MPa	9	H	1										
	0 ... 2.5 MPa	9	H	2										
	0 ... 4 MPa	9	H	3										
	0 ... 6 MPa	9	K	0										
	0 ... 10 MPa	9	K	1										
	0 ... 16 MPa	9	K	2										
0 ... 25 MPa	9	K	3											
0 ... 40 MPa	9	L	4											
0 ... 60 MPa	9	L	5											
Version	standard					S	0							
	for oxygen applications					S	1							
Switching contact	Contact N/O High-Side-Switch PNP							1						
	Contact N/C High-Side-Switch PNP							2						
Electrical connection	Swift connector without cable								0					
	Connector M12x1 ²⁾								3					
	Swift connector with cable 1.5 m								L					
Pressure connection ³⁾	Inside thread	7/16"-20 UNF sealing cone with Schrader				0				0	0	N		
		7/16"-20 UNF										K	1	
		G 1/4 with O-Ring seal FPM											1	1
		1/2"-14 NPT (≤ 6 MPa)											D	1
		M20x1.5 sealed at front and manometer (combi)											E	1
	Outside thread	7/16"-20 UNF sealing cone											2	1
		1/4"-18 NPT											3	1
		G 1/4 sealed at back DIN EN ISO 1179-2 with Profile seal ring in FPM											4	1
		R 1/4 acc. to EN 10226											7	1
		G 1/2 sealed at back and manometer with Profile seal ring in FPM											8	1
G 1/2 sealed at front											9	1		
Pressure tip orifice ²⁾	without (Inclusive pressure tip orifice from 10 MPa on)											0		
	with											2		
Material	Stainless steel 1.4305 / AISI 303												N	
pressure connection	Stainless steel 1.4404 / AISI 316L												1	
Switching points	Indicate W and state switching points on order (e.g.: W10/5MPa)													W

Accessories (supplied loose)	Order number
Swift connector	117312
Corner-wire box for connector M12x1 with cable 2.0 m	114604
Corner-wire box for connector M12x1	106975
Straight-wire box for connector M12x1	114570
Straight-wire box for connector M12x1 with cable 2.0 m	114605
Mounting bracket with screw	118716
Heat sink with outside thread G 1/2" sealed at front - inside thread G 1/2"	105631
Heat sink with outside thread G 1/2" sealed at front - inside thread G 1/4"	105073
Heat sink with outside thread G 3/4" sealed at front - inside thread G 1/4"	105074
Calibration certificate (at factory set switching points)	104551

Mounting bracket

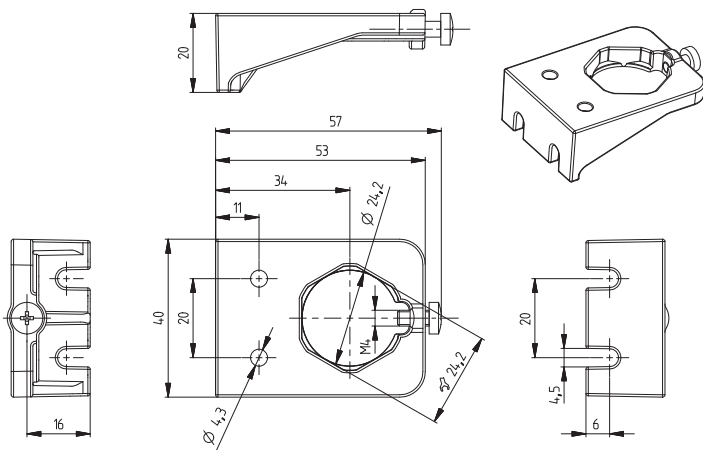

Heat sink

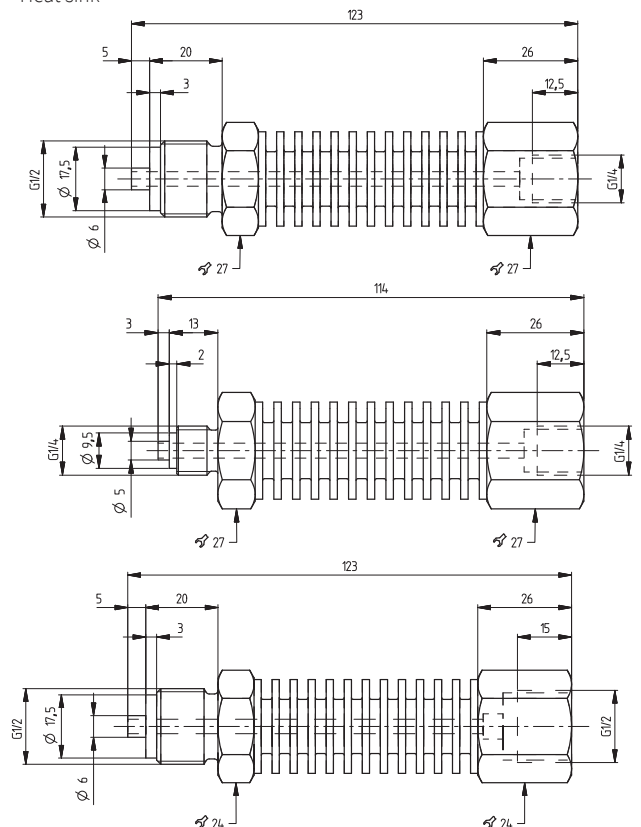

¹⁾ Other pressure ranges on request

²⁾ Delivery without female connector

³⁾ Other pressure connections on request

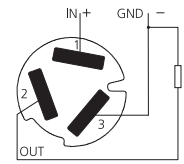
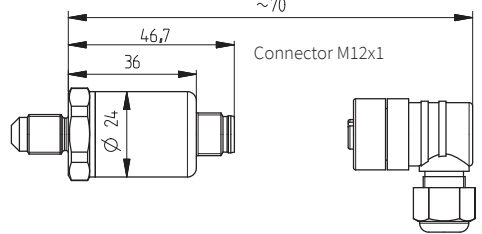
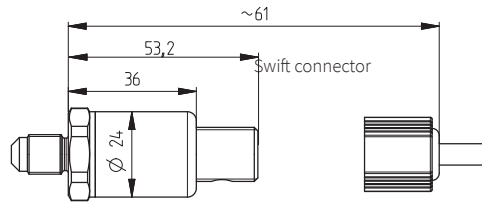
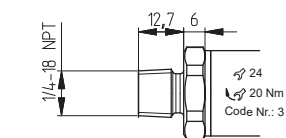
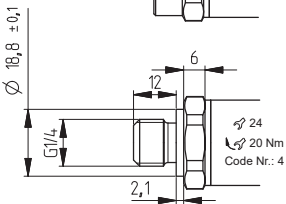
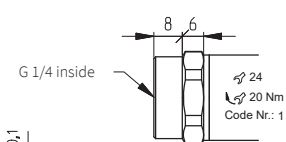
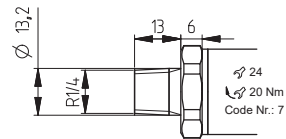
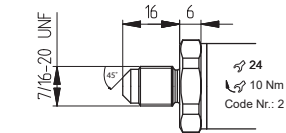
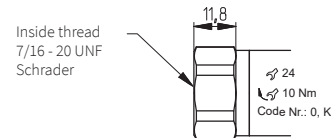
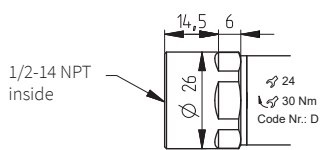
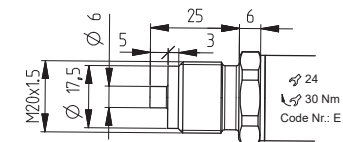
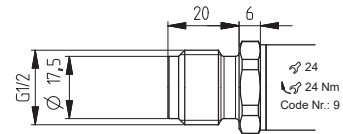
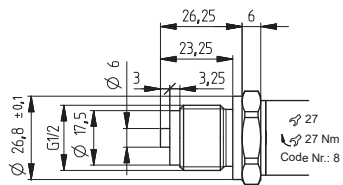

1= brown 2=green 3=white

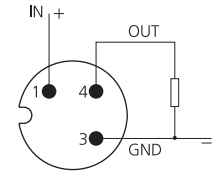

1 (IN) 4 (OUT) 3 (GND)

Function

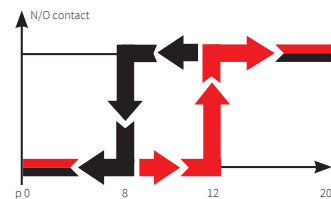
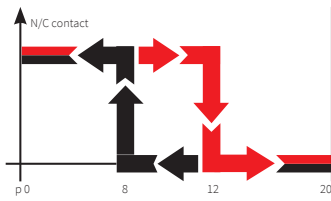

N/C contact: When pressure is applied ($p_0 \rightarrow p_{max}$) the switch will disconnect the applied load as soon as the upper switching point is reached. As the pressure falls ($p_{max} \rightarrow p_0$) the switch will connect the load as soon as the lower switching point is reached.

N/O contact: When pressure is applied ($p_0 \rightarrow p_{max}$) the switch will connect the applied load as soon as the upper switching point is reached. With a fall in pressure ($p_{max} \rightarrow p_0$) the switch will disconnect the load as soon as the lower switching point is reached.

Example: p_0 20 bar
 Upper switching point 12 bar
 Lower switching point 8 bar
 max. switching load 100 mA

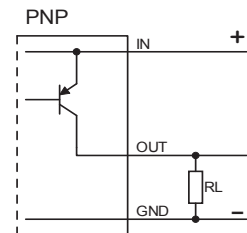

Huba Control AG

Headquarters Schweiz
Industriestrasse 17
CH-5436 Würenlos
Telefon +41 56 436 82 00
Fax +41 56 436 82 82
info.ch@hubacontrol.com

Huba Control AG

Vestiging Nederland
Hamseweg 20A
NL-3828 AD-Hoogland
Telefoon +31 33 433 03 66
Telefax +31 33 433 03 77
info.nl@hubacontrol.com

Huba Control AG

Niederlassung Deutschland
Schlattgrabenstrasse 24
D-72141 Walddorfhäslach
Telefon +49 7127 2393 00
Fax +49 7127 2393 20
info.de@hubacontrol.com

Huba Control USA, Inc.

Office United States of America
303 Wyman Street
Suite #300
Waltham MA 02451
Tel: +1 866-6HUBACO (+1 866-648-2226)
info.usa@hubacontrol.com

Huba Control SA

Succursale France
Rue Lavoisier
Technopôle Forbach-Sud
F-57602 Forbach Cedex
Téléphone +33 3 87 84 73 00
Télécopieur +33 3 87 84 73 01
info.fr@hubacontrol.com

Huba Control AG

Branch Office United Kingdom
Unit 13 Berkshire House, County Park Business
Centre, Shrivenham Road
Swindon Wiltshire SN1 2NR
Phone +44 1993 77 66 67
Fax +44 1993 77 66 71
info.uk@hubacontrol.com

www.hubacontrol.com

